

CONCEPT DRAWER / CASSETO CONCEPT / CAJÓN CONCEPT / TIROIR CONCEPT / GAVETA CONCEPT

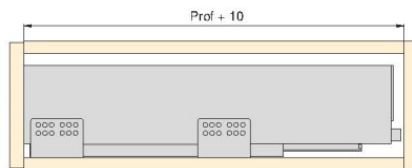

Prof.	L	B	C	H
300	298	128	293	105
350	348	128	343	138
400	398	192	393	185
450	448	224	443	
500	498	224	493	

PANEL DIMENSIONS - DIMENSIONI DEI PANNELLI
 DIMENSIONES DE PANELES - DIMENSIONS DES PANNEAUX
 DIMENSÕES DOS PAINÉIS

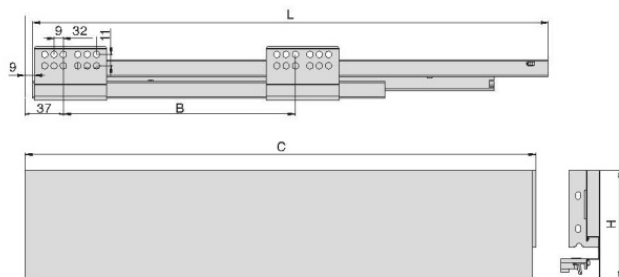
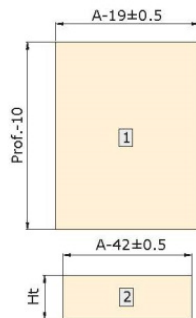
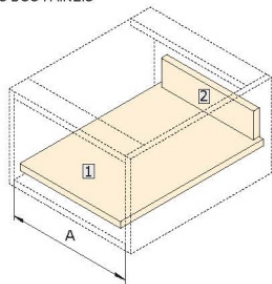

H	Ht
105	68
138	102
185	149

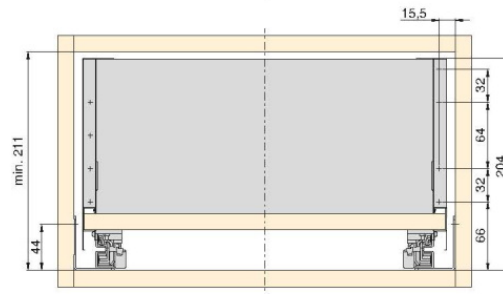
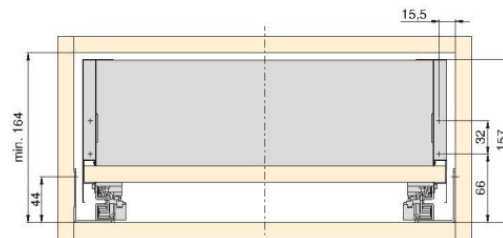
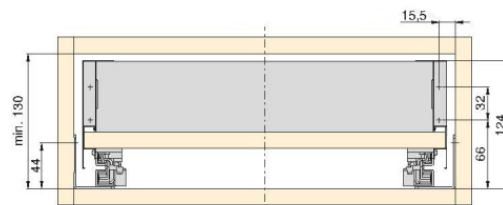

CONCEPT DRAWER / CASSETO CONCEPT / CAJÓN CONCEPT / TIROIR CONCEPT / GAVETA CONCEPT

ASSEMBLY - MONTAGGIO - MONTAJE - MONTAGE - MONTAGEM

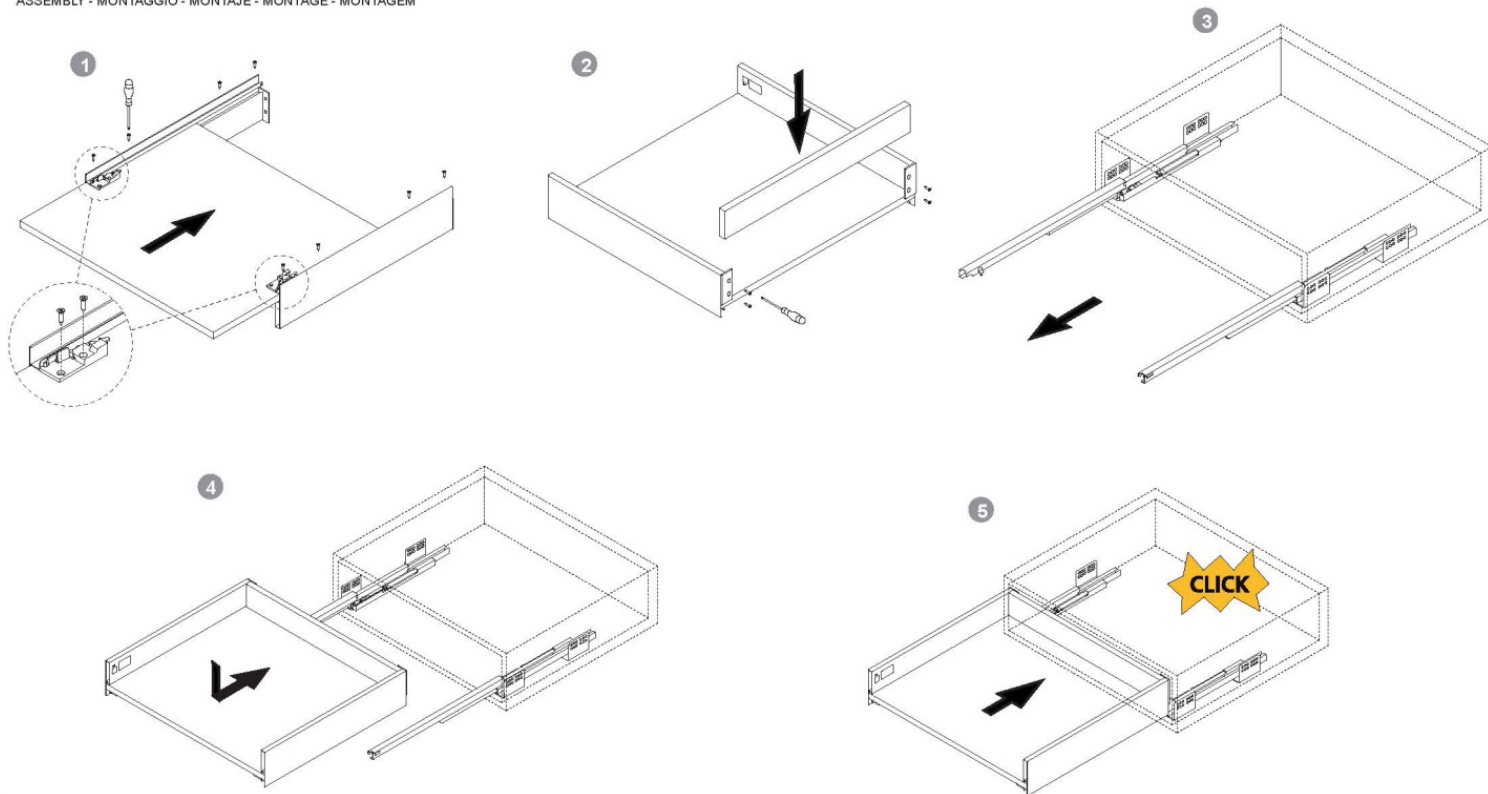

CONCEPT DRAWER / CASSETO CONCEPT / CAJÓN CONCEPT / TIROIR CONCEPT / GAVETA CONCEPT

6

H105
H138

H185

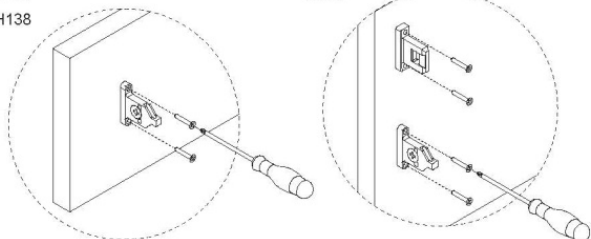

7

H105
H138

H185

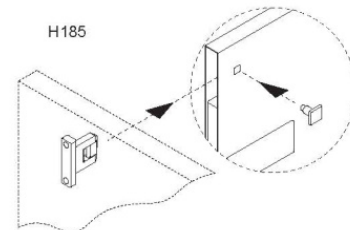
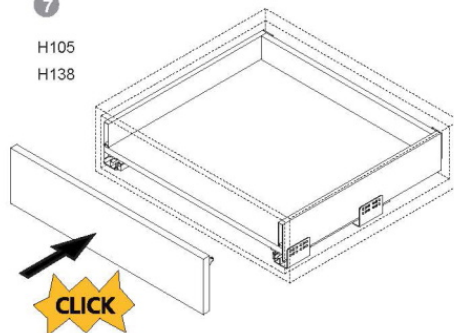

ADJUSTMENT - REGOLAZIONE - REGULACIÓN - RÉGLAGE - REGULACÃO

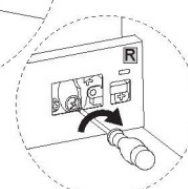
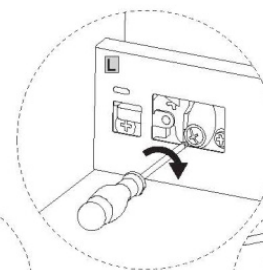
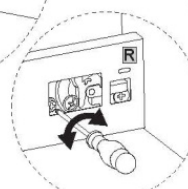
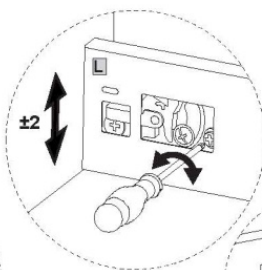
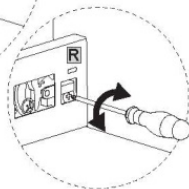
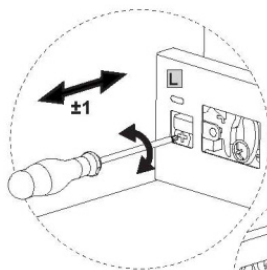
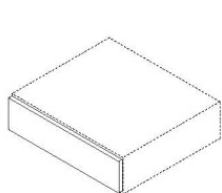

CONCEPT DRAWER / CASSETO CONCEPT / CAJÓN CONCEPT / TIROIR CONCEPT / GAVETA CONCEPT

DISMOUNTING - SMONTAGGIO - DESMONTAJE - DÉMONTAGE - DESMONTAGEM

